

E6040

**HYDRAULIC PILING
AND DIAPHRAGM WALL RIG**

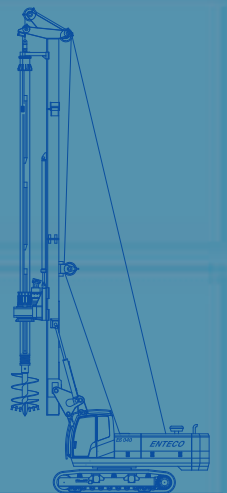

E6040

E 6 0 4 0



H Y D R A U L I C P I L I N G A N D D I A P H R A G M W A L L R I G

L'attrezzatura idraulica per pali e diaframmi E6040 è stata progettata per eseguire i seguenti lavori:

- Pali trivellati a secco o con fanghi bentonitici.
- Pali ad elica continua o con tecnologia soil displacement.
- Diaframmi.

Le principali caratteristiche sono:

- Peso con attrezzatura in condizioni di lavoro ~32÷40 tons.
- Max. momento torcente della rotary: 150 kNm.
- Max. profondità di perforazione: 50 m.
- Max. ϕ di perforazione lungo il mast: 1500 mm.
- Max. ϕ di perforazione sotto il mast: 2000 mm.
- Sottocarro allargabile da 2500 a 3700 mm.
- Motore diesel CATERPILLAR tarato a 250 HP/187 kW.
- Argano principale con tiro 150 kN, tamburo di grandi dimensioni per avvolgimento in unico strato: tiro costante e bassa usura della fune.
- Facilità di trasporto: non è necessario smontare alcun elemento.
- Automontante.
- Moderno e potente impianto idraulico proporzionale load sensing e cross sensing per una eccellente maneggevolezza della macchina, bassi consumi e massima produttività.
- Cabina ergonomica: l'operatore dispone della massima visibilità e può tenere l'argano principale sotto costante controllo visivo. I comandi dei sistemi di riscaldamento e di condizionamento sono integrati nella plancia.
- Apparecchiatura elettronica di controllo standard su video per tutte le versioni costituita da: indicatore di verticalità a crociera e numerico; indicatore di profondità con avvisatore acustico di avvicinamento e di raggiungimento quota di perforazione.
- Possono essere forniti, sulla stessa base macchina, diversi allestimenti di perforazione: per pali trivellati, CFA, soil displacement, per diaframmi.
- La macchina può essere predisposta con due sistemi di pull-down: cilindro o argano, da scegliere a seconda delle caratteristiche del sistema di perforazione.

The E6040 piling and diaphragm wall rig equipment has been designed to perform the following jobs:

- Bored piles, dry drilling or bentonite mud.
- Continuous flight auger piles (CFA), soil-displacement piles.
- Diaphragm walls.

Main features:

- Operating weight ~32÷40 tons.
- 150 kNm max. rotary torque.
- 50 m max. drilling depth.
- 1500 mm max. drilling diameter (tool in front of the mast).
- 2000 mm max. drilling diameter (tool beneath the mast).
- Expandable crawlers: from 2500 to 3700 mm.
- Diesel engine: CATERPILLAR 250 HP/187 kW rated power.
- Main winch line pull: 150 kN, large drum with rope working only on the 1st layer assure constant pull and prevent wear and tear.
- Easy transport: it can be transported without disassembling any components.
- Self erecting.
- Modern and powerful proportional LOAD SENSING and CROSS SENSING hydraulic system makes the machine easy to use and handle and allow an efficient use of engine and reduced fuel consumption.
- The cab is perfectly ergonomic: the driver has maximum visibility and can keep the main winch constantly under direct visual control. Heating and air conditioning are integrated into the control platform.
- Electronic control equipment: verticality display, depth display, drilling target approaching and reaching buzzer.
- Different drilling equipment (Bored Piling, Continuous Flight Auger, Soil-displacement piling, Diaphragm Walls) may be mounted on the same base machine.
- The machine may be equipped with two pull-down systems: cylinder or winch, to be chosen according to the drilling system requirements.



Studio accurato di ogni particolare per una attrezzatura di semplice utilizzo e manutenzione.

Precise project to the last detail for an equipment easy to handle and to maintain.



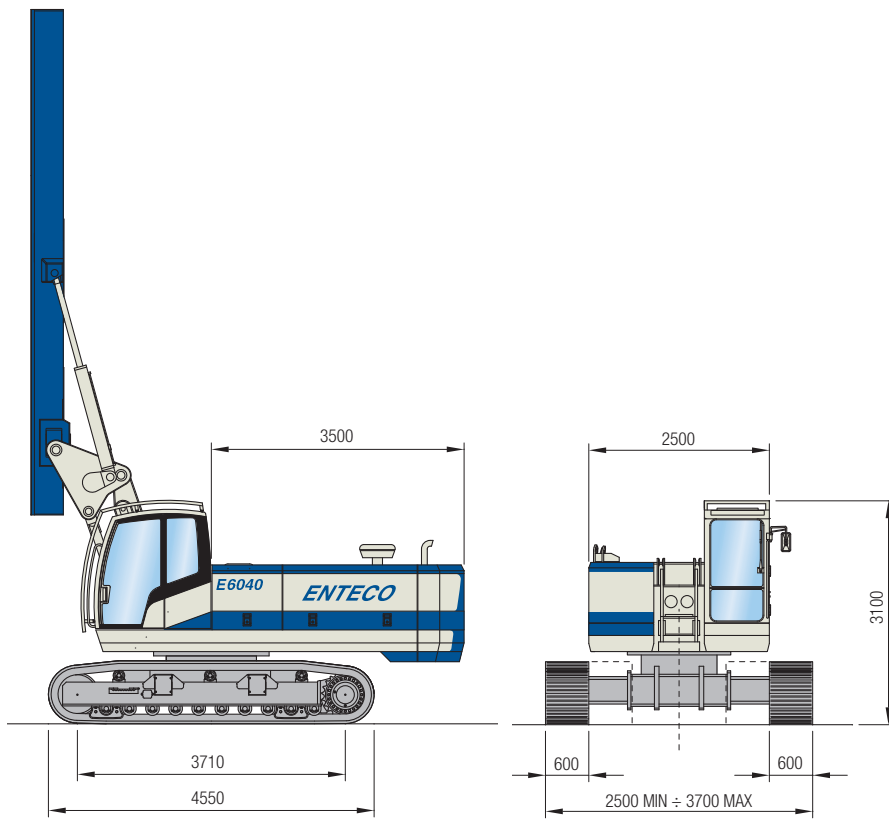

MACCHINA BASE E6040

Comprende il pantografo di supporto mast e l'elemento centrale del mast.

E6040 BASE MACHINE

Includes the Mast Support System and the central mast element.

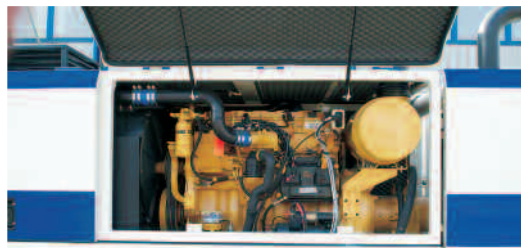

E6040 BASE MACHINE

DATI TECNICI MACCHINA BASE / BASE MACHINE TECHNICAL DATA

Cingoli		Crawlers	
Larghezza esterno cingoli	Overall width	mm	2500÷3700
Larghezza pattini	Track pads	mm	600
Velocità di traslazione	Crawlers tramming speed	km/h	2,1
Motore diesel		Diesel engine	
Tipo	Type		CATERPILLAR C7 ACERT
Potenza massima	Max. power	kW/HP	224/300
Potenza di taratura	Rated power	kW/HP	187/250
Vano motore insonorizzato	Soundproofed canopy		
Capacità serbatoio gasolio	Fuel tank capacity	l	350
Argano principale		Main winch	
Tiro max. primo strato	Max. line-pull 1 st layer	kN	150
Velocità max.	Max. speed	m/min	90
Dispositivo di caduta libera	Free-fall device		OPTION
Argano ausiliario		Auxiliary winch	
Tiro max. primo strato	Max. line-pull 1 st layer	kN	50
Velocità max.	Max. speed	m/min	80
Capacità fune	Drum capacity	m	83
Dispositivo di caduta libera	Free-fall device		OPTION

E6040

E 6 0 4 0

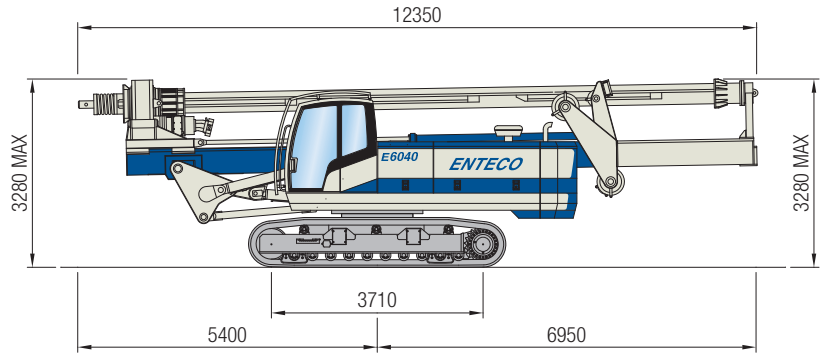
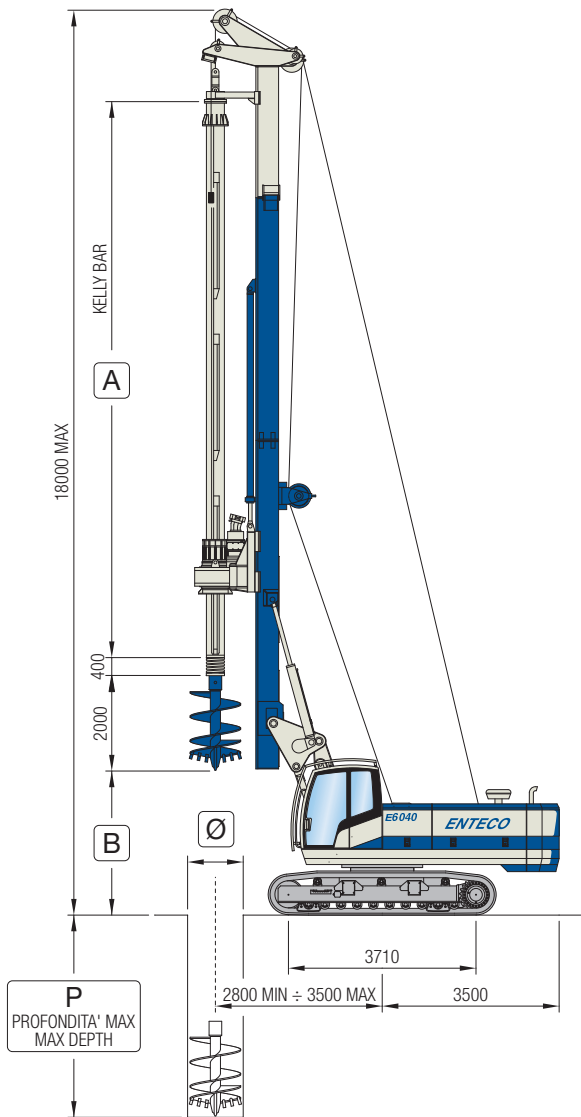

Dispositivo EIAS (Enteco Interactive Automation System) Sistema brevettato per l'automazione interattiva del ciclo di lavoro.

EIAS - The Enteco Interactive Automation System is a patented device for the interactive automation of the working cycle.



E6040 - R 150

E6040 CON KIT PER PALI TRIVELLATI DI GRANDE DIAMETRO / E6040 BORED PILE KIT

Testa Rotary Enteco R150	Enteco R150 Rotary head			
Coppia max.	Max. torque	kNm		150
Velocità max. di trivellazione	Max. drilling speed	rpm		31-64
Velocità di scarico	Spin-off speed	rpm		170
Diametro di perforazione elica fronte mast	Drilling diameter (auger in front of the mast)	(Ø) mm		1500
Diametro di perforazione elica sotto il mast	Drilling diameter (auger beneath the mast)	(Ø) mm		2000
Cilindro di pull-down	Pull-down cylinder			
Tiro max.	Max. extraction force	kN		150
Spinta max.	Max. thrust	kN		140
Corsa	Stroke	mm		3800
Aste a bloccaggio	Interlocking type kelly bar	A (mm)	B (mm)	P (m)
4x9 m	4x9 m	9000	3700	32
4x11 m	4x11 m	11000	2850	40
Aste a frizione	Friction type kelly bar	A (mm)	B (mm)	P (m)
5x9 m	5x9 m	9000	3700	40
5x11 m	5x11 m	11000	2850	50
Peso in ordine di lavoro (senza utensile)	Weight in working conditions (without tool)			Kg 41000
Peso in trasporto (senza contrappeso)	Weight in transport conditions (without counterweight)			Kg 38000
Peso in trasporto (senza contrappeso e kelly)	Weight in transport conditions (without counterweight and kelly bar)			Kg 32000

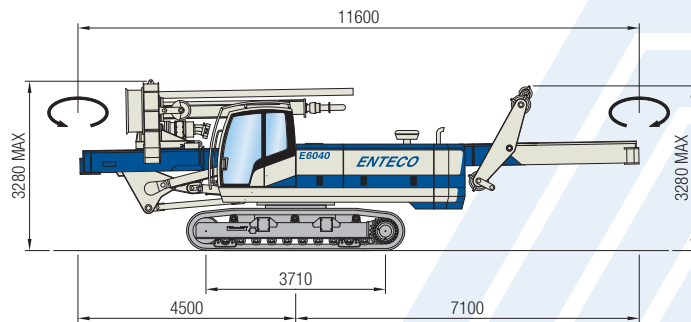
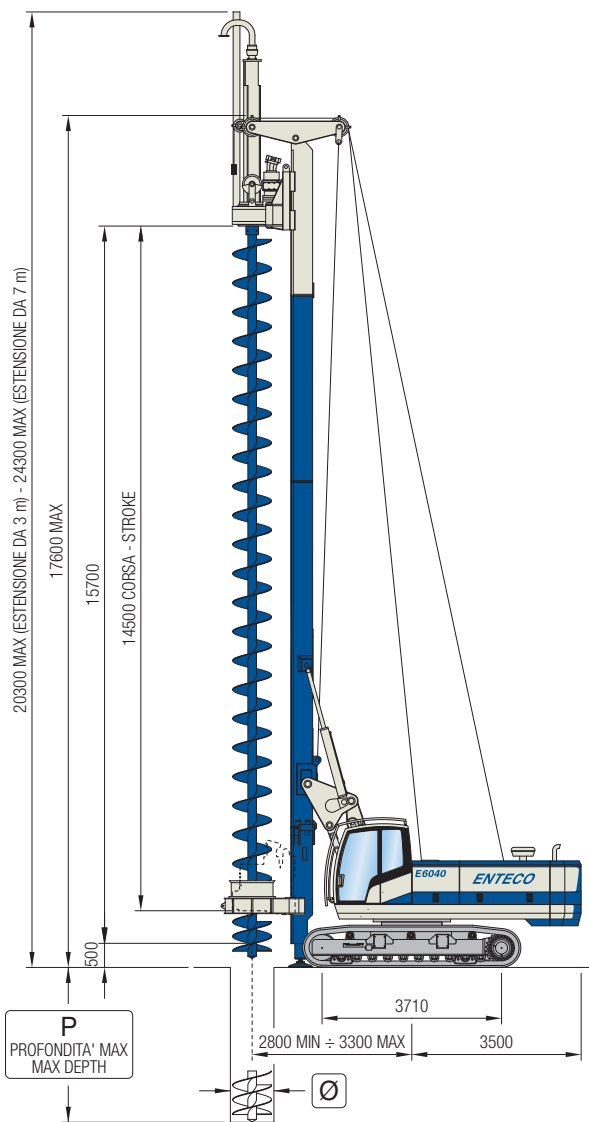

Apparecchiatura elettronica per la misurazione e memorizzazione dei parametri di perforazione e iniezione. Controllo automatico della risalita in funzione dell'iniezione del calcestruzzo.

Electronic monitoring system for the measurement and recording of drilling and injection parameters. Automatic control of withdrawal speed according to concrete (or grout) injection.



E6040 - CFA 150

E6040 CON KIT PER PALI AD ELICA CONTINUA / E6040 CONTINUOUS FLIGHT AUGER KIT

Dimensioni di scavo C.F.A.	Borehole dimensions C.F.A.	Senza estensione Without extension	Estensione 3 m 3 m extension	Estensione 7 m 7 m extension
Profondità max.	Max. depth	14500 mm	17500 mm	21500 mm
Profondità max. con pulisci elica rotante	Max. depth with rotative auger cleaner	13500 mm	16500 mm	20500 mm
Forza max. di estrazione	Max. extraction force			700 kN
Testa Rotary Enteco CFA 150	Enteco CFA 150 Rotary head			
Coppia max.	Max. torque		kNm	150
Velocità trivellazione max.	Max. drilling speed		rpm	31
Diametro di perforazione	Drilling diameter		(Ø) mm	500÷1200
Argano di pull-down	Pull-down winch			
Spinta max.	Max. thrust		kN	150
Peso in ordine di lavoro (senza utensile)	Weight in working conditions (without tool)			Kg 39000
Peso in trasporto (con contrappeso)	Weight in transport conditions (with counterweight)			Kg 39000
Peso in trasporto (senza contrappeso)	Weight in transport conditions (without counterweight)			Kg 36000

E6040

E 6 0 4 0

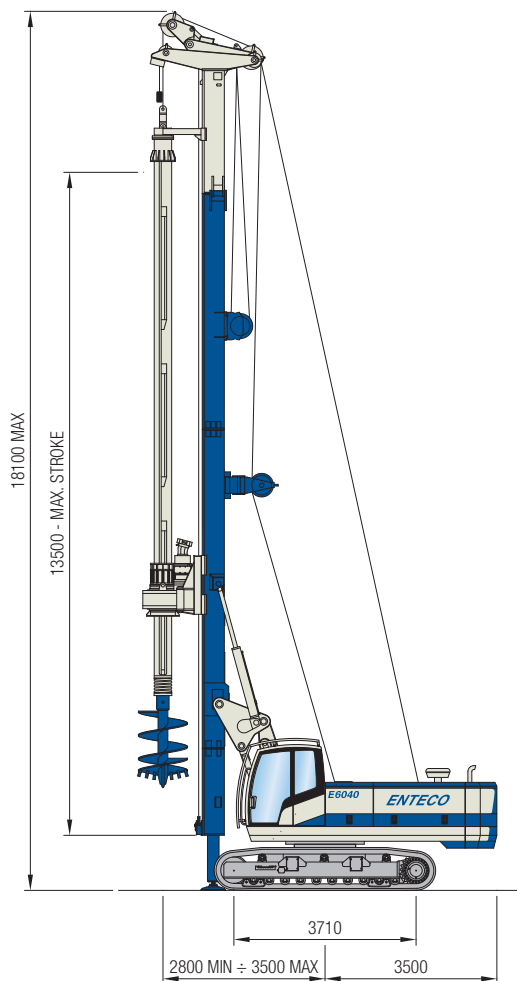

E6040M-R150

Kit pali trivellati
Bored pile kit

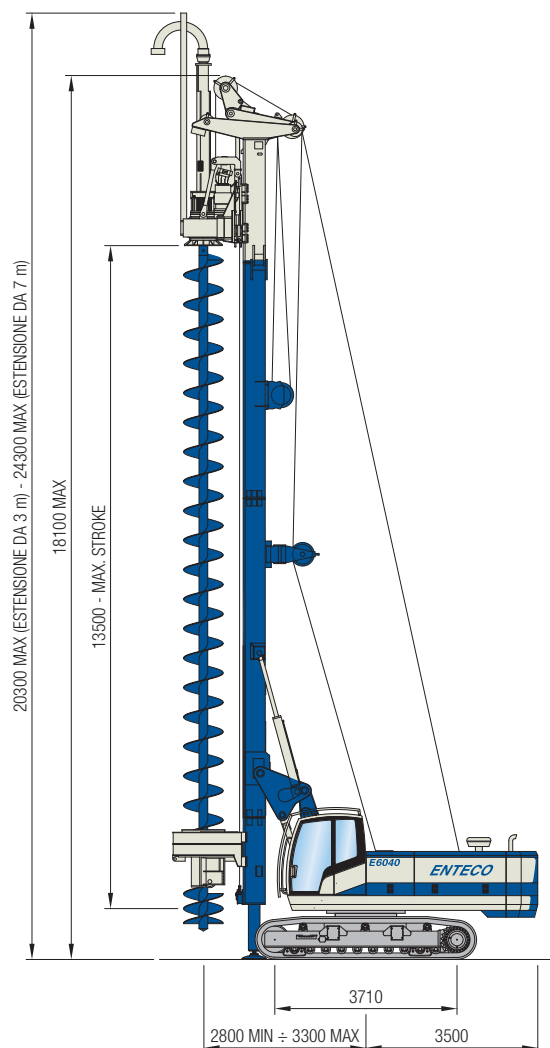

E6040M-CFA150

Kit elica continua
CFA kit

E6040M-R150 / E6040M-CFA150 / E6040M-SP150

E6040M

Testa Rotary Enteco R150

Enteco R150 Rotary head

Coppia max.	Max. torque	kNm	150
Velocità max. di trivellazione	Max. drilling speed	rpm	31-64
Velocità di scarico	Spin-off speed	rpm	170
Corsa	Stroke	mm	13500

Argano di pull-down

Pull-down winch

Tiro max.	Max. extraction force	kN	150
Spinta max.	Max. thrust	kN	150

Kit pali trivellati

Bored pile kit

Aste a bloccaggio	Interlocking type kelly bar	4x9/4x11	profondità/depth 32/40 m
Aste a frizione	Friction type kelly bar	5x9/5x11	profondità/depth 40/50 m

Kit elica continua

CFA kit

Forza max. di estrazione	Max. extraction force	kN	450
--------------------------	-----------------------	----	-----

Kit soil displacement

Soil-displacement kit

Diametro di perforazione	Drilling diameter	mm	350-600
--------------------------	-------------------	----	---------

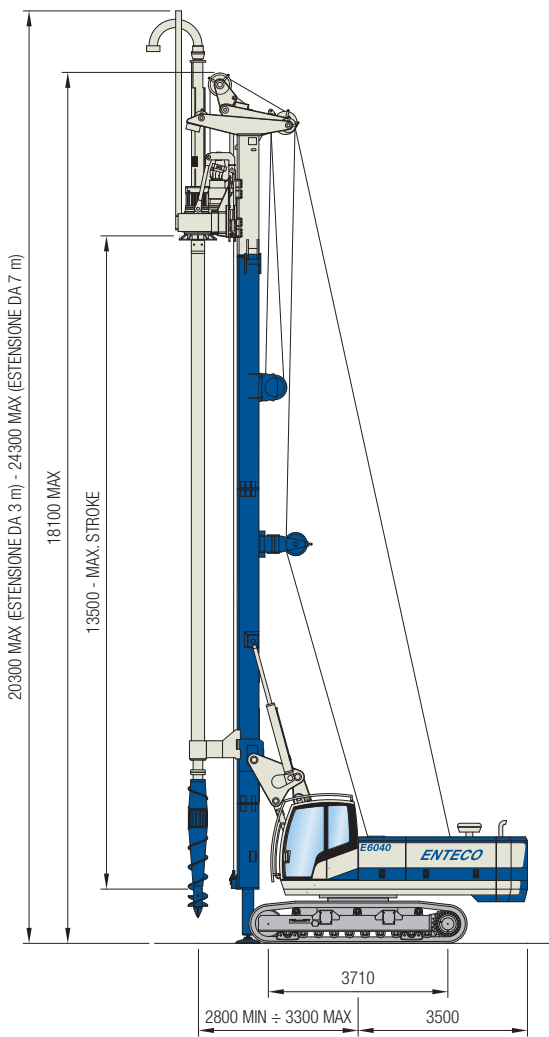

E6040M-SP150
Kit soil displacement
Soil-displacement kit

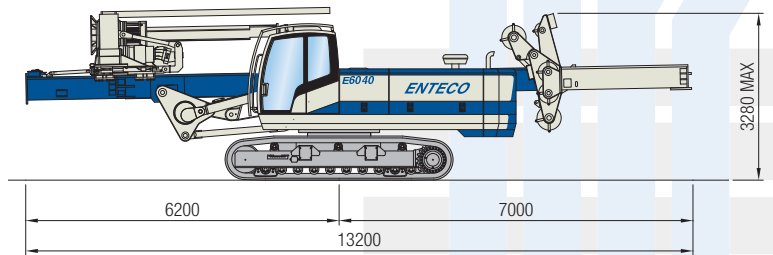
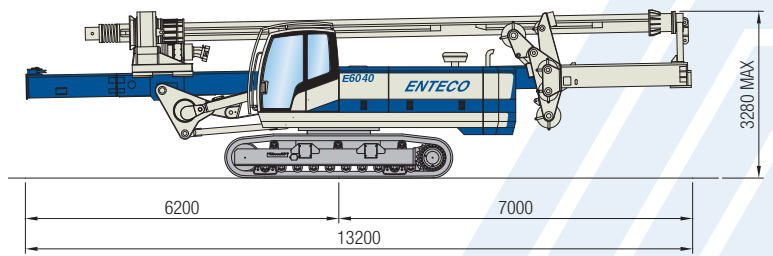

L'apparecchiatura elettronica della E6040M riunisce in un unico sistema il dispositivo EIAS brevettato ENTECO per l'automazione del ciclo di lavoro con Kelly e il sistema di controllo e memorizzazione per CFA e Soil Displacement.

The electronic control system of the E6040M groups together the EIAS - Enteco Interactive Automation System for the automation of Kelly-bar working cycle, and the monitoring and recording system for CFA and Soil-Displacement.



La versione M (multipurpose) della E6040 differisce dalla versione standard per la conformazione del piede, del falcone e della componentistica idraulica ed elettrica per permettere un rapido passaggio dall'utilizzo per pali trivellati all'elica continua e al soil displacement.

Non sono necessarie modifiche alla macchina ma solamente la sostituzione degli utensili con le relative aste o estensioni dell'elica. Con questa attrezzatura in pochi minuti, direttamente in cantiere, l'operatore può passare da una tecnica di perforazione all'altra con sensibile riduzione dei costi di trasporto e di trasformazione.

The "M" version of the E6040 has been specifically designed to allow for quick changeovers from bored-piling to CFA and/or Soil-displacement piling. No modifications to the machine are required: just the replacement of the drilling tools with the relevant Kelly, augers and/or extensions.

The E6040M can be converted in a few minutes directly on site thus making considerable savings on down-time, transport and modification costs.

Le macchine possono essere personalizzate con optional e modifiche a richiesta del cliente.

The E6040 can be custom-made with several options and modifications to suit customer's requirements.



E6040

E 6 0 4 0

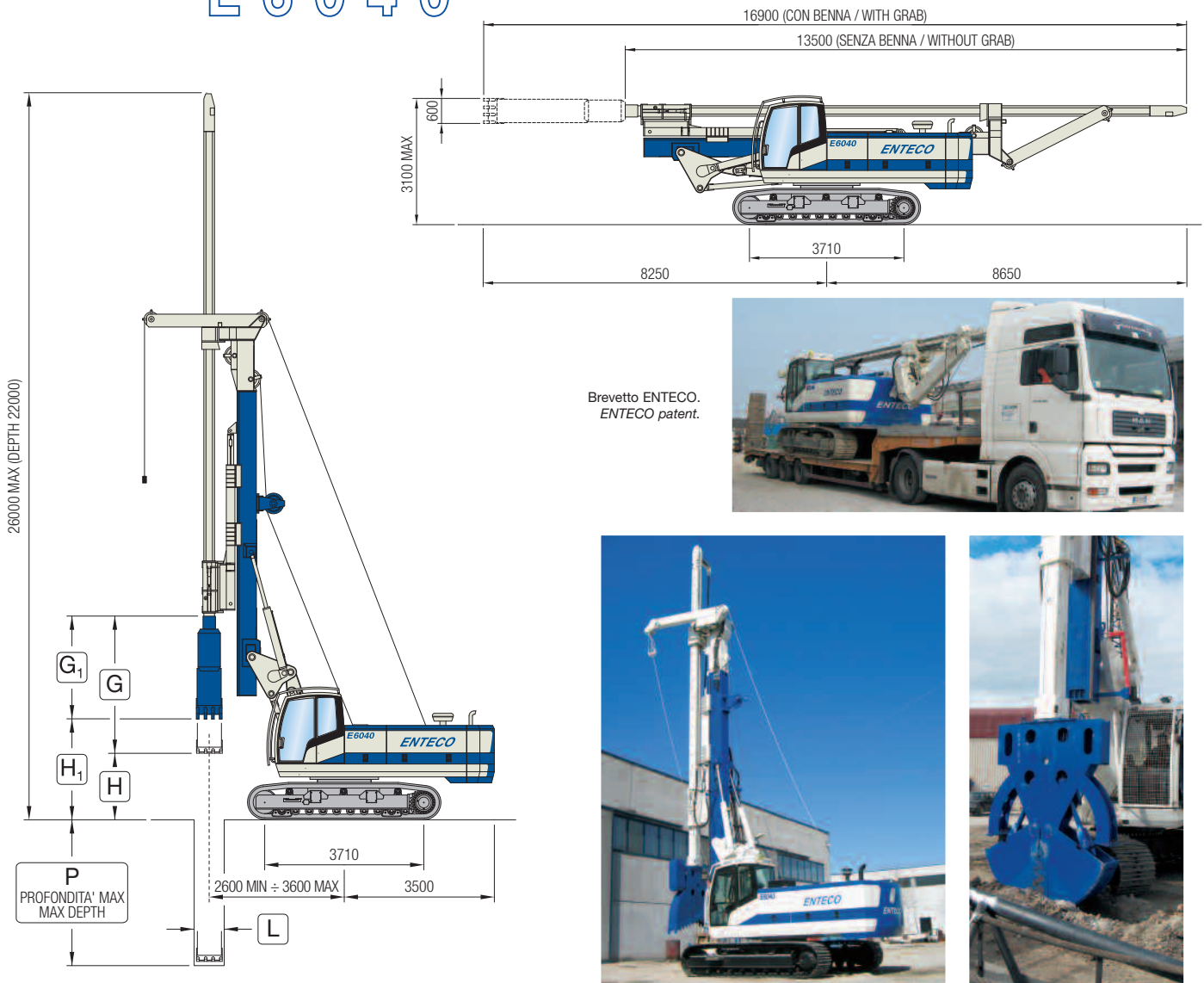

E6040 - HGM 20

E6040 CON KIT PER DIAFRAMMI ASTA MONOBLOCCO / E6040 DIAPHRAGM WALL KIT (MONOBLOC KELLY)

Benna idraulica da diaframmi mod. HG3 / Mod. HG3 diaphragm hydraulic grab		Apertura valve = 2000 / Jaws opening = 2000		Apertura valve = 2500 / Jaws opening = 2500	
Altezza benna a valve chiuse / Grab height with closed jaws	G	3150 mm		3400 mm	
Altezza benna a valve aperte / Grab height with open jaws	G ₁	2450 mm		2500 mm	
Altezza da terra a valve chiuse / Height with closed jaws	H	2350 mm		2100 mm	
Altezza da terra a valve aperte / Height with open jaws	H ₁	3050 mm		3000 mm	
Cilindro pull-down / Pull-down cylinder					
Corsa / Stroke		mm		3800	
Spinta max. / Max. thrust		kN		140	
Diaframma / Diaphragm wall					
Profondità / Depth	P	m		22	
Larghezza / Width	L	mm		300÷1200	
Peso in ordine di lavoro (senza benna) / Weight in working conditions (without grab)					Kg ~36000
Peso in trasporto (senza benna) / Weight in transport conditions (without grab)					Kg ~36000
Peso in trasporto (senza benna e contrappeso) / Weight in transport conditions (without grab and counterweight)					Kg ~33000
Peso benna / Grab weight					Kg ~2400-3000

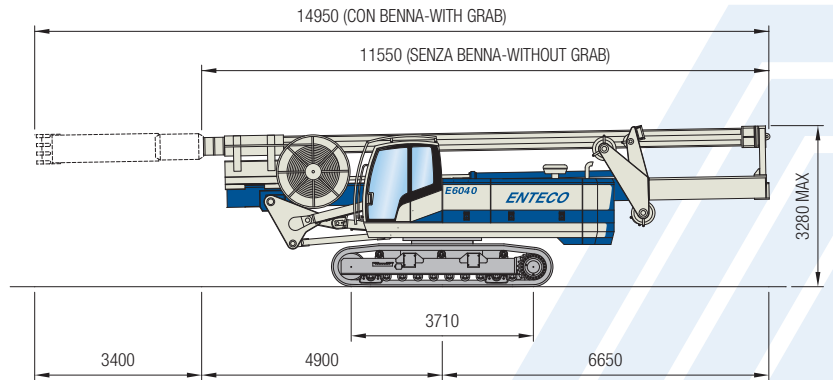
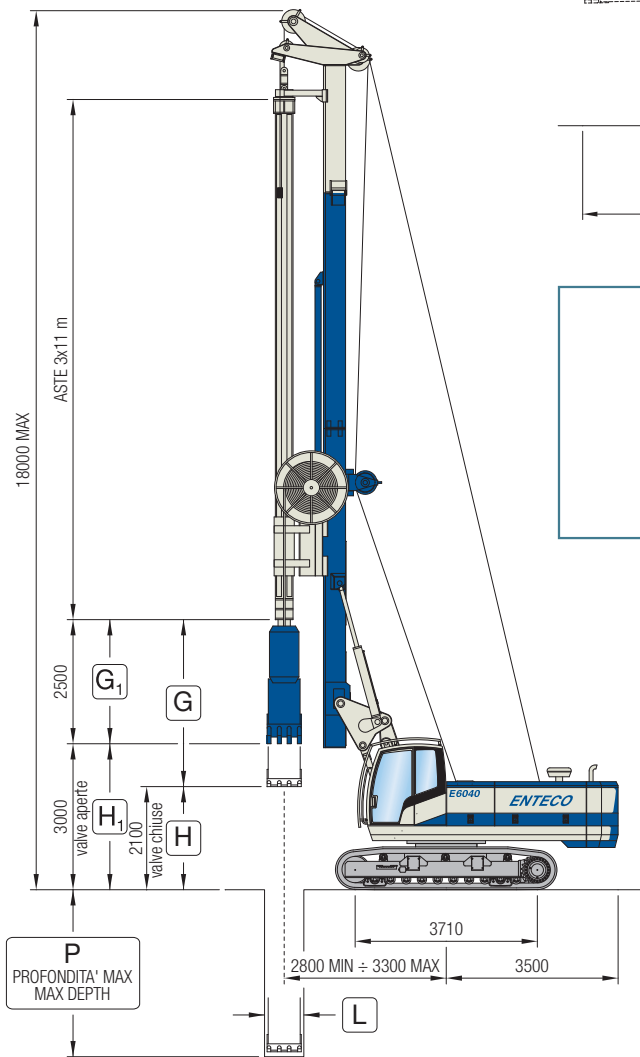

HGM - HGT sistema brevettato esclusivo ENTECO.
 Attrezzatura per diaframmi con spinta sulla benna,
 setti con spessore minimo di 300 mm,
 scavo direttamente in adiacenza a pareti.

HGM - HGT unique Diaphragm-Wall equipment
 patented by ENTECO, fitted with a crowd system,
 capable of using 300 mm wide grab
 and operating adjacent to existing walls.



E6040 - HGT 30

E6040 CON KIT DIAFRAMMI ASTA TELESCOPICA / E6040 DIAPHRAGM WALL KIT (TELESCOPIC KELLY)

Benna idraulica da diaframmi mod. HG3	Mod. HG3 diaphragm hydraulic grab		Apertura valve = 2000 Jaws opening = 2000	Apertura valve = 2500 Jaws opening = 2500
Altezza benna a valve chiuse	Grab height with closed jaws	G	3150 mm	3400 mm
Altezza benna a valve aperte	Grab height with open jaws	G₁	2450 mm	2500 mm
Altezza da terra a valve chiuse	Height with closed jaws	H	2350 mm	2100 mm
Altezza da terra a valve aperte	Height with open jaws	H₁	3050 mm	3000 mm
Cilindro pull-down		Pull-down cylinder		
Corsa	Stroke		mm	3800
Spinta max.	Max. thrust		kN	140
Diaframma		Diaphragm wall		
Profondità	Depth	P	m	30
Larghezza	Width	L	mm	300÷1200
Peso in ordine di lavoro (senza benna)	Weight in working conditions (without grab)			Kg ~38000
Peso in trasporto (senza benna)	Weight in transport conditions (without grab)			Kg ~38000
Peso in trasporto (senza benna e contrappeso)	Weight in transport conditions (without grab and counterweight)			Kg ~35000
Peso benna	Grab weight			Kg ~2400-3000

E6040

E 6 0 4 0



*Cantiere Genova (Italia).
E6040M con kit pali trivellati.
Viadotto ferroviario
pali Ø 1000-1400 mm.*

*Genoa (Italy).
Railway viaduct.
E6040M with bored-piles kit.
Pile dia. 1000-1400 mm.*

*Cantiere ferrovia alta velocità
Milano - Torino (ITALIA).
E6040-R150.
Pali Ø 1800 mm. profondità
40 metri.*

*Italian High-Speed Railway,
Milan - Turin section:
E6040-R150.
Pile dia. 1800 mm.
depth: 40 m.*





San Pietroburgo (Russia).
E6040-CFA150.
Fondazioni edificio industriale.

S. Petersburg (Russia).
Foundation piles for an industrial building.



BOMBAY (INDIA).
E6040-R150.
Pali trivellati per fondazioni edificio residenziale.

Mumbai (India):
E6040-R150.
Bored-piles for a residential building.



Cantiere RIMINI (ITALIA).
E6040-HGM20.
Diaframmi spessore 300 mm.

Rimini (Italy): E6040-HGM20.
Diaphragm-walls 300 mm wide.



MESSICO E6040-R150.
Pali trivellati per fondazioni ponte autostradale.

Mexicali (Mexico): E6040-R150.
Bored-piles for highway bridge foundations.



Sidney e Melbourne (Australia).
N° 2 E6040M complete di kit pali trivellati, elica continua e kit per diaframmi HGM 20.

Sydney and Melbourne (Australia): E6040M.
Multi-purpose rigs, each equipped with bored-piles, CFA and HGM-20 attachments.



SPAGNA E6040M.
con kit pali trivellati ed elica continua.

Spain: E6040M.
Dual-use rig: equipped with bored-piles and CFA attachments.





Enteco è presente in ogni continente e in molti paesi del mondo, con dealers specializzati e competenti che seguono clienti e cantieri con disponibilità e professionalità.

Enteco is to be found on all continents and in many countries throughout the world, with specialised, competent dealers who willingly follow customers and sites with great professionalism.



Via dell'Artigianato, 33 - z.i. - 30020 Fossalta di Piave - Venezia - Italy
Tel. +39 0421 679977 - Fax +39 0421 679993 - E-mail: info@entecodrill.com - www.entecodrill.com